

# NETATMO

BY  
STARCK®

additional smart radiator valve  
ek akıllı radyatör vanası

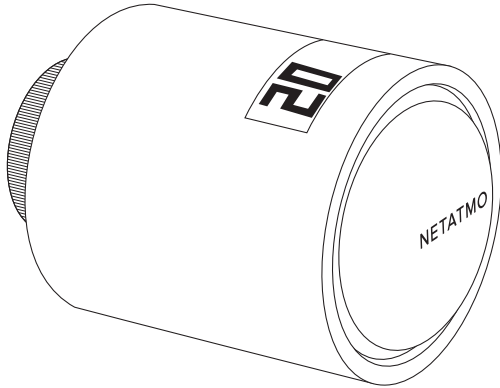

EN Quick installation guide | Additional Smart Radiator Valve  
TR Kolay kurulum kılavuzu / ek radyatör vanası



**EN** You can watch an installation tutorial video online at the following address:

**TR** Kurulum için eđitici videoları ařađıdaki adreste bulabilirsiniz:

<https://addvalve.netatmo.com>



**EN** **Read these instructions carefully before starting the installation.**  
The device is for indoor use only and must be protected from damp and dust as well as solar radiation.



**TR**

**Kuruluma başlamadan önce tüm yönergeleri dikkatlice okuyun**

Bu cihaz sadece iç mekan kullanımı içindir, toz nem ve direkt güneş ışığından uzak tutun.

## In the box Kutu içeriđi

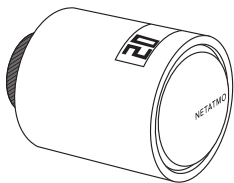

1. One Smart Radiator Valve  
1. Bir akıllı radyatör vanası



2. One set of 2 AA batteries  
2. Bir set 2 adet AA pil

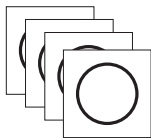

3. One set of colour adhesives  
3. Bir set renkli yapıştırıcı



4. One set of radiator adaptors  
and accessories

4. Bir set radyatör adaptörü ve aksesuarı

**EN**

**In the box:**

1. One Smart Radiator Valve
2. One set of 2 AA batteries
3. One set of colour adhesives
4. One set of radiator adaptors  
and accessories

**TR**

**Kutu içeriği:**

1. Bir Akıllı radyatör vanası
2. Bir set 2 adet AA pils
3. Bir set renkli yapıştırıcı
4. Bir set radyatör adaptörü ve  
aksesuarı

## Compatibility Uyumluluk

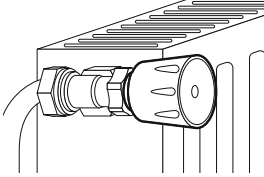

1

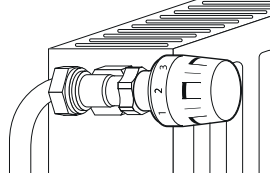

2

### EN Compatibility

There are two types of radiator valves: manual valves (1), and thermostatic valves (2).

Thermostatic valves (usually with numbered graduation marks from 1 to 5) can be easily replaced with the Netatmo Valve.

Note: If your installation also includes manual valves you can leave them as they are or call a professional to replace them.

### TR Uyumluluk

İki tip radyatör vanası vardır: manuel vanalar (1) ve termostatik vanalar (2). Termostatik vanalar (genellikle 1'den 5'e kadar numaralandırılmıştır) Netatmo vanası ile kolayca değiştirilebilir. Not: Kurulumunuz manuel vanalar da içeriyorsa, bunları olduğu gibi bırakabilir veya değiştirmek için bir uzmanı arayabilirsiniz.



# Application Uygulama



**EN** Before inserting the batteries into your valves,  
download the mobile application Energy Netatmo.  
To find out how to remotely control your Valves from  
your smartphone or tablet, go to:

**TR** Pilleri yerleřtirmeden önce Energy Netatmo uygulamasını indirin.  
Enerji Netatmo mobil uygulamasını indirin. Vanalarınızı akıllı  
telefonunuzdan veya tabletinizden uzaktan nasıl kontrol  
edeceđinizi öğrenmek için řu adrese gidin:

<https://valve.netatmo.com>

# Batteries

## Piller

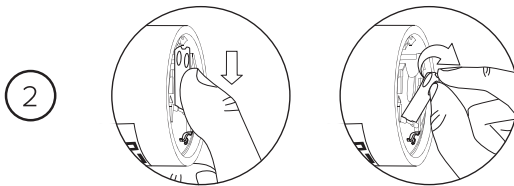
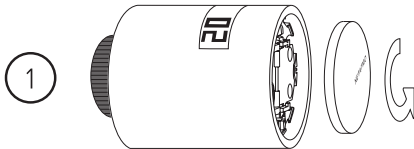

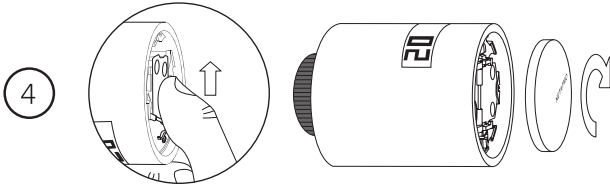
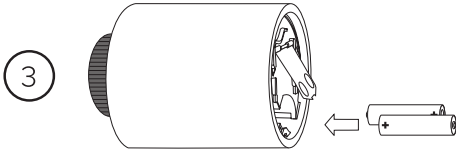

EN

Follow the steps below, only when required in the application

1. Open the front panel of the Valve using a small anti-clockwise rotation.
2. Open the metal battery cover.
3. Insert the batteries ensuring the positive and negative ends correspond.
4. Close the metal battery cover and replace the front panel.

TR

Uygulamadan istendiğinde aşağıdaki adımları takip edin:

1. Ön kapağı saat yönünün tersine çevirerek açın
2. Metal pil koruyucuyu çıkartın
3. Artı Eksi yöne dikkat ederek pilleri yerleştirin
4. Metal koruyucu ve kapağı kapatın

# Customisation Özelleştirme

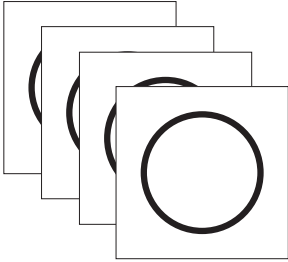

1

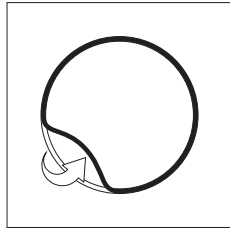

2

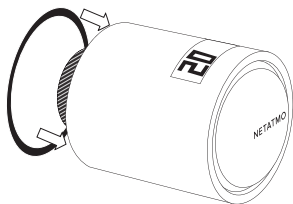

3

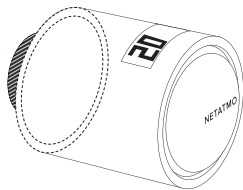

4

EN

### Customisation

You can customise each Valve using one of the colour adhesives provided.

TR

### Özelleştirme

Renkli yapıştırıcıları kullanarak Vanaları özelleştirebilirsiniz. .

# Installation Kurulum

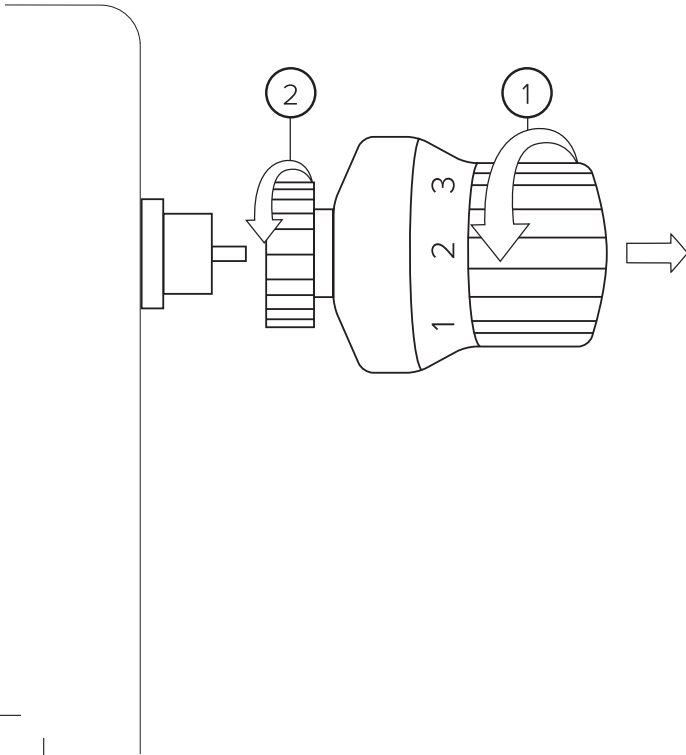

**EN**

**Removing the old valve**

Rotate the valve counter-clockwise to remove it from the radiator (1).  
Unscrew the securing ring (2) and remove the valve.

**TR**

**Eski vanayı sökmek**

Vanayı saat yönünün tersine çevirin ve radyatörden çıkartın (1) Koruma yüzüğünün vidalarını sökün ve vanayı çıkartın (2) .

# Radiator Adaptors Radyatör adaptörleri

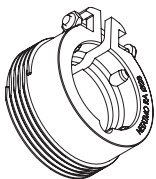

Danfoss RA

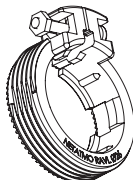

Danfoss RAVL



M30 x 1.5



M30 x 1



M28 x 1.5

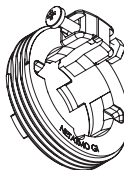

Giacomini (GI)



**EN** Use the **adaptor selection guide** provided to choose the adaptor that fits onto your radiator valve body. For more help, you can use our online compatibility tool at:

**TR** Adaptör seçim kılavuzunu kullanarak **vana gövdesine uyumlu adaptörü seçin**. Daha fazla yardım için çevrimiçi uyumluluk aracını kullanın:

<https://check.netatmo.com>

## Valve installation Vana kurulumu

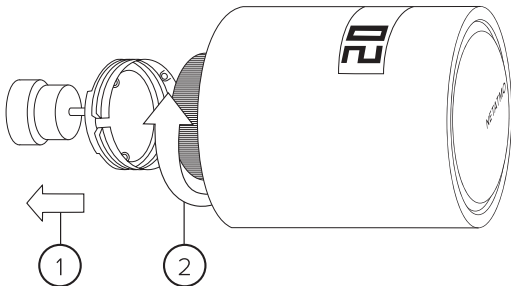

EN

### Valve installation

Fit the suitable adaptor (1) onto the valve body. Then, screw the Netatmo Valve onto the adaptor (2) while turning it to ensure the display faces the right direction.

TR

### Vana kurulumu

Uygun adaptörü vana gövdesine yerleştirin. (1) Adaptöre Netatmo Vana'yı yerleştirin, ekranın doğru yerde olduğundan emin olun.

## Test Test

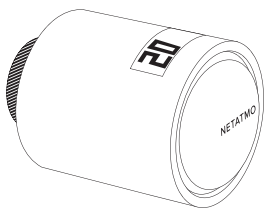

1

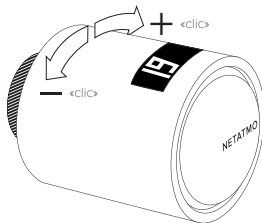

2

**EN** The display shows the room temperature (1). To increase/ decrease the temperature setpoint on the Valve, twist the cylinder clockwise/anticlockwise. The manual setpoint is temporarily displayed on a black background (2).

**TR** Ekran oda sıcaklığını göstermektedir. (1) Sıcaklığı arttırmak veya azaltmak için cihazı saat yönünde ya da saat yönünün tersine çeviriniz. Set ayarı bir süre siyah arka planlı olarak görülür. (2)

Installation advice  
Kurulum önerileri

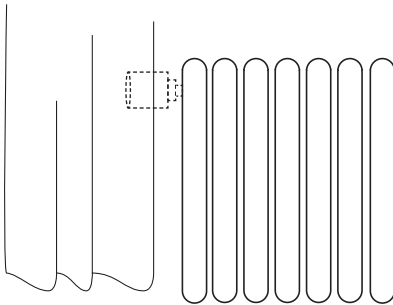
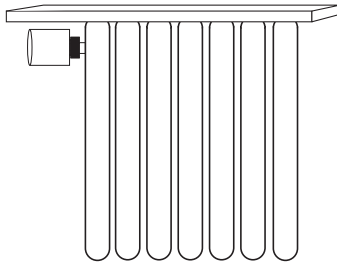

**EN**

**Installation advice**

Do not block air ventilation next to the Valve (curtain, radiator cover...)  
Do not cover.

**TR**

**Kurulum önerileri**

Vananın önündeki hava akımını kapatmayın. (perde, radyatör korusu...)  
Üstünü örtmeyin.

# Technical specification

## ENGLISH

### SIZE

Valve: 58 mm (diameter), 80 mm (L)

### WEIGHT

Valve: 186 g (including batteries)

### DESIGN

Designed by Starck

### SENSORS AND MEASUREMENTS

Temperature (measurement):

Range: 0°C to 50°C

Accuracy: +/- 0.5°C

Temperature (setpoint):

Range: 5°C to 30°C

Increment: 0.5°C

Motor:

Linear motion: 8 mm max

Noise level: < 35 dBA

Spring force: 80 N max

### E-PAPER DISPLAY

Energy efficient, longer battery life and optimal readability.

### FREE APP, LIFETIME SUPPORT

No subscription fee. App available on the App Store and on Google Play. Free access to your online personal dashboard. Accessible from multiple devices.

### WIRELESS SPECIFICATIONS

Wireless connection between Valves and Relay: long-range radio (868.9-869.1, 869.7-869.9 MHz @16mW).

### POWER AND BATTERIES ( PER VALVE)

Two 1.5V AA batteries.

Two year-battery life.

### SETUP AND COMPATIBILITY ( PER VALVE)

6 radiator adaptors suitable for use with the following valve bodies: M30x1.5, M30x1.0, M28x1.5, Danfoss RAVL, Danfoss RA, Giacomini.

### **SAFETY WARNINGS**

This device must be installed according to the applicable norms. Use only with supplied power plug adaptor. This device is for indoor use only. Before inserting the batteries, check that the contacts in the device and on the batteries are clean, is necessary clean them. Note the polarity (+/-) when inserting the batteries. Do not throw the batteries into a fire, short-circuit them or dismantle them. Keep children away from batteries. Seek medical attention immediately if a battery is swallowed. Do not attempt to repair the device yourself; customer service is available. Any changes or modifications to this unit not expressly approved by the party responsible for compliance could void the user's authority to operate the equipment.

This device is not intended for use by persons (including children) with reduced physical, sensory or mental capabilities, or lack of experience and knowledge, unless they have been given supervision or instruction concerning use of the appliance by a person responsible for their safety. Children should be supervised to ensure that they do not play with the appliance.

# Teknik Özellikler

## TÜRKÇE

### BOYUT

Vana: 58 mm (çap), 80 mm (uzunluk)

### AĞIRLIK

Vana 186 g (piller dahil)

### TASARIM

Starck tarafından tasarlanmıştır

### SENSÖR VE ÖLÇÜMLER

Sıcaklık (ölçümler)

Aralık: 0 - 50 °C

Artış: 0.5 °C

Motor:

Lineer hareket: 8 mm maksimum

Ses Seviyesi: <35dBA

Yay kuvveti: 80 N maksimum

### EKRAN

Enerji verimliliği, uzun pil ömrü, optimal okunabilirlik

### BEDAVA UYGULAMA, ÖMÜR BOYU DESTEK

Abonelik ücreti yok. App Store ve Google Play Store'da uygulama bulunabilir. Birden farklı cihazdan bağlanabilme.

### KABLOSUZ BAĞLANTI ÖZELLİKLERİ

Vana ve röleler arasındaki kablosuz bağlantı: 868.9-869.1 , 869.7-869.9 MHz @16mW)

### GÜÇ VE PİLLER

İki 1.5V AA piller

İki yıllık pil ömrü

### KURULUM VE UYUMLULUK

Aşağıdaki valf gövdeleri ile kullanıma uygun 6 radyatör adaptörü: M30x1.5, M30x1.0, M28x1.5, Danfoss RAVL., Danfoss RA, Giacomini..



## **GÜVENLİK UYARILARI**

Bu cihaz yürürlükteki normlara göre kurulmalıdır. Yalnızca birlikte verilen elektrik fişi adaptörüyle kullanın. Bu cihaz yalnızca iç mekanda kullanım içindir. Pilleri takmadan önce, cihazdaki ve pillerdeki temas noktalarının temiz olup olmadığını kontrol edin, gerektiğinde temizleyin. Pilleri yerleştirirken kutuplara (+/-) dikkat edin. Pilleri ateşe atmayın, kısa devre yaptırmayın veya parçalarına ayırmayın. Çocukları akülerden uzak tutun. Pili yutulursa derhal tıbbi yardım alın. Cihazı kendiniz onarmaya çalışmayın; Bu ünite, uyumluluktan sorumlu tarafça açıkça onaylanmayan değişiklik ya da düzenleme yapılması, kullanıcının ekipmanı kullanma yetkisini geçersiz kılabılır.

# EU Declaration of Conformity

**Česky [Czech]** - Netatmo tímto prohlašuje, že tento NRV01 je ve shodě se základními požadavky a dalšími příslušnými ustanoveními směrnice 2014/53/UE a ROHS 2011/65/ES. Originál EU prohlášení o shodě lze nalézt na <http://www.netatmo.com/declaration/nav>.

**Dansk [Danish]** - Undertegnede Netatmo erklærer herved, at følgende udstyr NRV01 overholder de væsentlige krav og øvrige relevante krav i direktiv 2014/53/UE og ROHS 2011/65/EF. Den oprindelige EU-overensstemmelseserklæringen kan findes på <http://www.netatmo.com/declaration/nav>.

**Deutsch [German]** - Hiermit erklärt Netatmo, dass sich das Gerät NRV01 in Übereinstimmung mit den grundlegenden Anforderungen und den übrigen einschlägigen Bestimmungen der Richtlinie 2014/53/UE und ROHS 2011/65/EG befindet. Die Original-EU-Konformitätserklärung finden Sie unter <http://www.netatmo.com/declaration/nav>.

**Eesti [Estonian]** - Käesolevaga kinnitab Netatmo seadme NRV01 vastavust direktiivi 2014/53/UE ja ROHS 2011/65/EÜ põhinõuetele ja nimetatud direktiivist tulenevatele teistele asjakohastele sätetele. Vastavusdeklaratsiooni tervikteksti saab veebilehelt <http://www.netatmo.com/declaration/nav>.

**English** - Hereby, Netatmo declares that this NRV01 is in compliance with the essential requirements and other relevant provisions of Directive 2014/53/UE and ROHS 2011/65/EC. The original EU declaration of conformity may be found at <http://www.netatmo.com/declaration/nav>.

**Español [Spanish]** - Por medio de la presente Netatmo declara que el NRV01 cumple con los requisitos esenciales y cualesquiera otras disposiciones aplicables o exigibles de la Directiva 2014/53/UE y ROHS 2011/65/CE. El original de la declaración de conformidad UE se puede encontrar en <http://www.netatmo.com/declaration/nav>.

**Ελληνική [Greek]** - Με την παρούσα Netatmo δηλώνει ότι NRV01 συμμορφώνεται προς τις ουσιαστικές απαιτήσεις και τις λοιπές σχετικές διατάξεις της οδηγίας 2014/53/UE και ROHS 2011/65/ΕΚ. Μπορείτε να βρείτε ένα αντίγραφο της πλήρους δήλωσης συμμόρφωσης στη διεύθυνση <http://www.netatmo.com/declaration/nav>.

**Français [French]** - Par la présente Netatmo déclare que l'appareil NRV01 est conforme aux exigences essentielles et aux autres dispositions pertinentes de la directive 2014/53/UE et ROHS 2011/65/CE. La déclaration de conformité UE originelle est disponible sur <http://www.netatmo.com/declaration/nav>.

**Hrvatski [Croatian]** - Ovimе, Netatmo izjavljuje da je ovaj NRV01 u skladu s osnovnim zahtjevima i drugim relevantnim odredbama Direktive 2014/53/UE i ROHS 2011/65/EC. Kopija pune izjave o sukladnosti mođe se preuzeti na <http://www.netatmo.com/declaration/nav>.

**Italiano [Italian]** - Con la presente Netatmo dichiara che questo NRV01 è conforme ai requisiti essenziali ed alle altre disposizioni pertinenti stabilite dalla direttiva 2014/53/UE e ROHS 2011/65/CE. La dichiarazione di conformità UE originale si trova a <http://www.netatmo.com/declaration/nav>.

**Latviski [Latvian]** - Ar šo Netatmo deklarē, ka NRV01 atbilst Direktīvas 2014/53/UE un ROHS 2011/65/EK būtiskajām prasībām un citiem ar to saistītajiem noteikumiem. Pilnas atbilstības deklarācijas kopiju var iegūt vietnē <http://www.netatmo.com/declaration/nav>.

**Lietuvių [Lithuanian]** - Šiuo Netatmo deklaruoja, kad šis NRV01 atitinka esminius reikalavimus ir kitas 2014/53/UE ir ROHS 2011/65/EB Direktyvos nuostatas. Originali EU atitikties deklaracija yra <http://www.netatmo.com/declaration/nav>.

**Nederlands [Dutch]** - Hierbij verklaart Netatmo dat het toestel NRV01in overeenstemming is met de essentiële eisen en de andere relevante bepalingen van richtlijn 2014/53/UE en ROHS 2011/65/EG. De oorspronkelijke EU-verklaring van overeenstemming is te vinden op <http://www.netatmo.com/declaration/nav>.

**Malti [Maltese]** - Hawnhekk, Netatmo, jidkijjara li dan NRV01 jikkonforma mal-htigijiet essenzjali u ma provvedimenti oħrajn relevanti li hemm fid-Direttiva 2014/53/UE u ROHS 2011/65/EC. Kopja tad-Dikjarazzjoni shiha ta 'konformità tista' tinkiseb fuq <http://www.netatmo.com/declaration/nav>.

**Magyar [Hungarian]** - Alulírott, Netatmo nyilatkozom, hogy a NRV01 megfelel a vonatkozó alapvető követelményeknek és az 2014/53/UE i ROHS 2011/65/EC irányelv egyéb előírásainak. Az eredeti EU megfeleléségi nyilatkozat megtalálható a <http://www.netatmo.com/declaration/nav> oldalon.

**Norsk [Norwegian]** - Erklærer herved Netatmo at dette NRV01 er i samsvar med de grunnleggende krav og øvrige relevante krav i direktiv 2014/53/UE og ROHS 2011/65/EC.

En kopi av den fullstendige samsvarserklæringen kan fås ved <http://www.netatmo.com/declaration/nav>.

**Polski [Polish]** - Niniejszym Netatmo oświadczam, że NRV01 jest zgodny z zasadniczymi wymogami oraz pozostałymi stosownymi postanowieniami Dyrektywy 2014/53/UE i ROHS 2011/65/EC. Kopię pełnej deklaracji zgodności można pobrać pod adresem <http://www.netatmo.com/declaration/nav>.

**Svenska [Swedish]** - Härmed intygar Netatmo att denna NRV01 står i överensstämmelse med de väsentliga egenskapskrav och övriga relevanta bestämmelser som framgår av direktiv 2014/53/UE och ROHS 2011/65/EG. En kopia av hela Konformitetsdeklarationen finns på <http://www.netatmo.com/declaration/nav>.

**Português [Portuguese]** - Netatmo declara que este NRV01 está conforme com os requisitos essenciais e outras disposições da Directiva 2014/53/UE e ROHS 2011/65/CE.

Uma cópia completa da declaração de conformidade pode ser obtida em <http://www.netatmo.com/declaration/nav>.

**Română [Romanian]** - Asteft, Netatmo declară că acest NRV01 este în conformitate cu cerințele esențiale și alte prevederi relevante ale Directivei 2014/53/UE și ROHS anului 2011/65/CE. O copie a declarației de conformitate completă poate fi obținută la <http://www.netatmo.com/declaration/nav>.

**Slovensko [Slovenian]** - Netatmo izjavlja, da je ta NRV01 v skladu z bistvenimi zahtevami in ostalimi relevantnimi določili direktive 2014/53/UE in ROHS 2011/65/ES. Kopijo celotne izjave o skladnosti najdete na spletni povezavi <http://www.netatmo.com/declaration/nav>.

**Slovensky [Slovak]** - Netatmo týmto vyhlasuje, že NRV01 spĺňa základné požiadavky a všetky príslušné ustanovenia Smernice 2014/53/UE a ROHS 2011/65/ES. Úplné znenie Vyhlásenia o zhode nájdete na webovej stránke <http://www.netatmo.com/declaration/nav>.

**Suomi [Finnish]** - Netatmo vakuuttaa täten että NRV01 tyyppinen laite on direktiivin 2014/53/UE ja ROHS 2011/65/EY oleellisten vaatimusten ja sitä koskevien direktiivin muiden ehtojen mukainen. Alkuperäinen EU-vaatimustenmukaisuusvakuutus on osoitteesta <http://www.netatmo.com/declaration/nav>.

**Türkçe [Turkish]** - Netatmo, bu NRV01'in 2014/53/UE ve ROHS 2011/65/EC Yönetmeliğinin temel şartlarını ve diğer ilgili hükümlerine uygun olduğunu beyan eder.

Tam uygunluk beyanının bir kopyası <http://www.netatmo.com/declaration/nav> adresinden edinilebilir.

**Български [Bulgarian]** - С настоящото Netatmo декларира, че това NRV01 е в съответствие със съществените изисквания и другите приложими разпоредби на Директива 2014/53/UE и ROHS 2011/65/EC. Копие от пълния декларацията за съответствие може да бъде получена на <http://www.netatmo.com/declaration/nav>.

Netatmo SAS – 93, rue Nationale – 92100 Boulogne-Billancourt



Boulogne-Billancourt, 12/06/2017  
CEO  
Frédéric POTTER

# NETATMO

① <http://support.netatmo.com>



Copyright Netatmo © 2017 All rights reserved.  
Reproduction and distribution prohibited without written authorization from Netatmo  
Apple and the Apple logo are trademarks of Apple Inc., registered in the U.S. and other countries. App Store is a service mark of Apple Inc., registered in the U.S. and other countries.  
Google Play and the Google Play logo are trademarks of Google Inc.

QSG-NAV-V5