

NETATMO

BY

STARCK®

smart radiator valves starter pack

Akıllı radyatör vanası başlangıç paketi

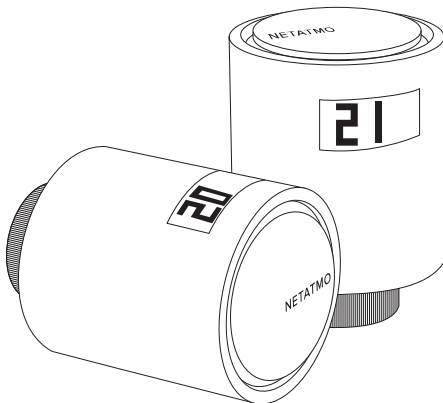

EN Quick installation guide | Starter Pack for collective or district heating
TR Hızlı kurulum kılavuzu / Toplu veya bölgesel ısıtma için Başlangıç Paketi



EN You can watch an installation tutorial video online at the following address:

TR Kurulum için eđitici videoları ařađıdaki linki kullanarak izleyebilirsiniz:

<https://starterpack.netatmo.com>



EN **Read these instructions carefully before starting the installation.**
The Starter Pack is for indoor use only and must be protected from damp and dust as well as solar radiation.

TR **Kuruluma başlamadan önce yönergeleri dikkatli bir şekilde okuyun.**
Başlangıç Paketi sadece iç mekan kullanımı içindir nem ve tozlu ortamlardan ve direkt güneş ışığı altından uzak tutunuz.

EN This Starter Pack is exclusively for district or collective heating. If your heating installation includes an individual heating system (such as a boiler) connected to a Netatmo Thermostat, buy the Additional Smart Radiator Valves directly. If you already own a central thermostat, first buy a Netatmo Smart Thermostat then Additional Smart Radiator Valves. For more information, please visit:

TR Bu Bařlangıç Paketi sadece bölgesel ya da toplu ısıtma iindir. Isıtma tesisatınızda Netatmo Termostatına baėlı ayrı bir ısıtma sistemi (bir kazan gibi) varsa, Ek Akıllı Radyatör Valflerini doėrudan satın alın. Zaten merkezi bir termostatınız varsa, önce bir Netatmo Akıllı Termostat sonra Ek Akıllı Radyatör Vanaları satın alın. Daha fazla bilgi için lütfen ziyaret edin:

<https://www.netatmo.com>

In the box

Kutunun içinde neler var

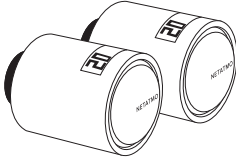

1. Two Smart Radiator Valves
1. İki Akıllı Radyatör Vanası

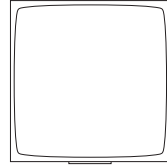

2. One Relay
2. Bir adet röle

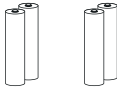

3. Two sets of 2 AA batteries
3. İki set 2 adet AA pil

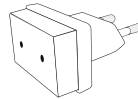

4. Power plug
4. Güç adaptörü

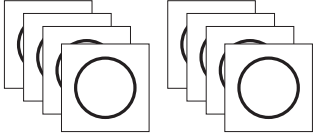

5. Two sets of colour adhesives
5. İki set renkli yapışkan bant



6. Two sets of radiator adaptors and accessories
6. İki set radyatör adaptörü ve aksesuarı

EN

In the box:

1. Two Smart Radiator Valves
2. One Relay
3. Two sets of 2 AA batteries

4. Power plug
5. Two sets of colour adhesives
6. Two sets of radiator adaptors and accessories

TR

Kutuda:

1. İki Akıllı Radyatör Vanası
2. Bir röle
3. İki set 2 AA pil

4. Güç adaptörü
5. İki set renkli yapışkan bant
6. İki set radyatör adaptörü ve aksesuarı

Compatibility

Uyumluluk

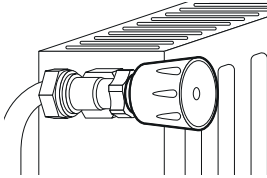

1

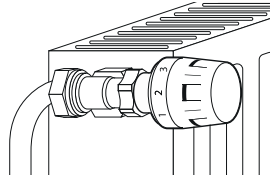

2

EN

Compatibility

There are two types of radiator valves: manual valves (1), and thermostatic valves (2).

Thermostatic valves (usually with numbered graduation marks from 1 to 5) can be easily replaced with the Netatmo Valve.

Note: If your installation also includes manual valves you can leave them as they are or call a professional to replace them.

TR

Uyumluluk

İki tip radyatör vanası bulunur: manual vanalar (1) ve termostatik vanalar (2).

Termostatik vanalar (genellikle 1 den 5 'e kadar numaralandırılmıştır,) kolaylıkla Netatmo Vanaları ile değiştirilebilirler.

Not: Eğer kurulumunuz manual vana da içeriyorsa vanaları olduğu gibi bırakabilir ya da değişim için bir profesyonel çağırabilirsiniz.

Application Uygulama

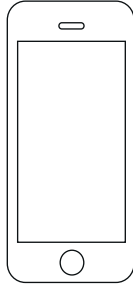

EN Before inserting the batteries into your Valves, download the mobile application Energy Netatmo. To find out how to remotely control your Valves from your smartphone or tablet, go to:

TR Vanaların içine pilleri takmadan önce Netatmo Enerji uygulamasını indirin
Vanalarınızı akıllı telefon yada tableten kontrol etmek için:

<https://valve.netatmo.com>

The Relay

Röle

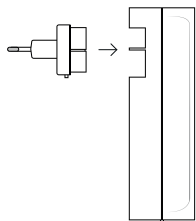

1

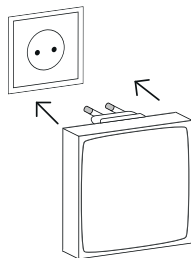

2

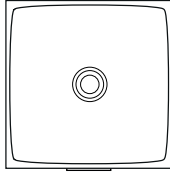

3

EN

Relay

1. Connect the power plug to the Relay.
2. Plug the Relay in a central location in your home to ensure connection to all Valves.
3. The light on the Relay blinks.

TR

Röle

1. Röleye güç adaptörünü takın
2. Röleyi evinizde merkezi bir noktaya yerleştirin
3. Röle üzerindeki ışıklar yanacaktır.

Batteries

Piller

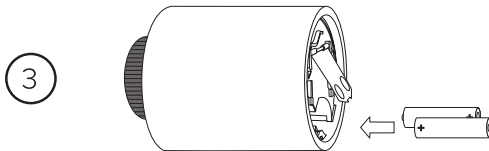
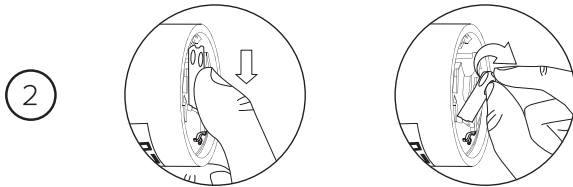
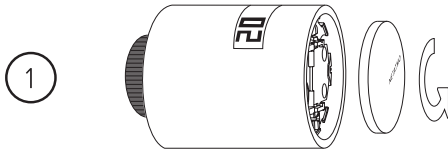

4

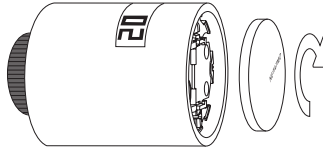
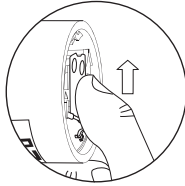

EN Follow the steps below, only when required in the application

1. Open the front panel of the Valve using a small anti-clockwise rotation.
2. Open the metal battery cover.
3. Insert the batteries ensuring the positive and negative ends correspond.
4. Close the metal battery cover and replace the front panel.

TR Aşağıdaki adımları uygulama tarıfınan talep edildiğinde gerçekleştirin:

1. Vananın ön tarafını saat yönünün tersine çevirerek açın
2. Metal pil koruyucusunu çıkartın
3. Artı eksi bağlantıya dikkat ederek pilleri yerleştirin
4. Metal pil koruyucusunu ve ön kapağı kapatın.

Customisation Özelleştirme

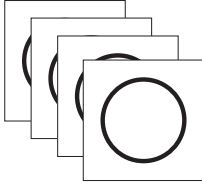

1

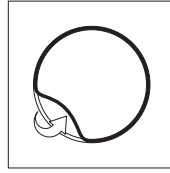

2

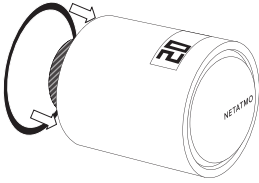

3

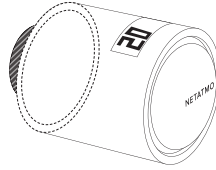

4

EN

Customisation

You can customise each Valve using one of the colour adhesives provided.

TR

Özelleştirme

Renkli yapışkanları kullanarak vanalarınızı özelleştirebilirsiniz.

Installation Kurulum

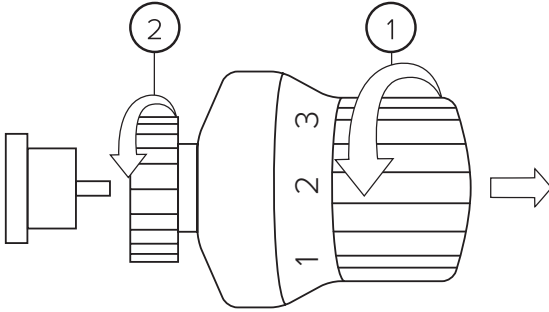

- EN** **Removing the old valve**
Rotate the valve counter-clockwise to remove it from the radiator (1).
Unscrew the securing ring (2) and remove the valve.
- TR** **Eski vanaları sökme**
vanayı saat yönünün tersine çevirin ve radyatörden çıkartın

Radiator Adaptors

Radyatör Adaptörleri



Danfoss RA



Danfoss RAVL



M30 x 1.5



M30 x 1



M28 x 1.5

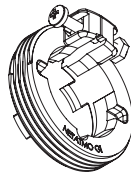

Giacomini (GI)

EN Use the **adaptor selection guide** provided to choose the adaptor that fits onto your radiator valve body. For more help, you can use our online compatibility tool at:

TR Radyatör valfi gövdesine uyan adaptörü seçmek için **adaptör seçim kılavuzunu** kullanın. Daha fazla yardım için şu adresteki çevrimiçi uyumluluk aracımızı kullanabilirsiniz:

<https://check.netatmo.com>

Valve installation

Vana kurulumu

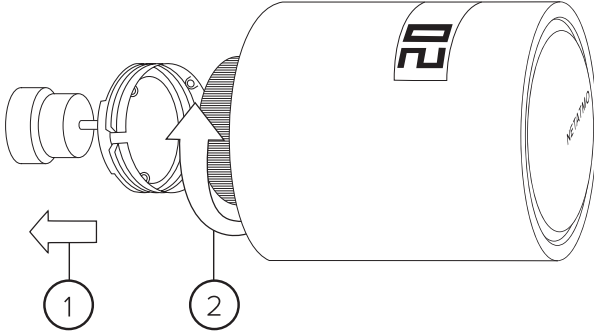

- EN** **Valve installation**
Fit the suitable adaptor (1) onto the valve body. Then, screw the Netatmo Valve onto the adaptor (2) while turning it to ensure the display faces the right direction.
- TR** **Vana kurulumu**
Uyumlu adaptörü vana gövdesine yerleştirin (1). Netatmo Vana'sını adaptöre vidalayın (2). Bu işlemi yaparken ekranın doğru yönde olduğundan emin olun.

Test Test

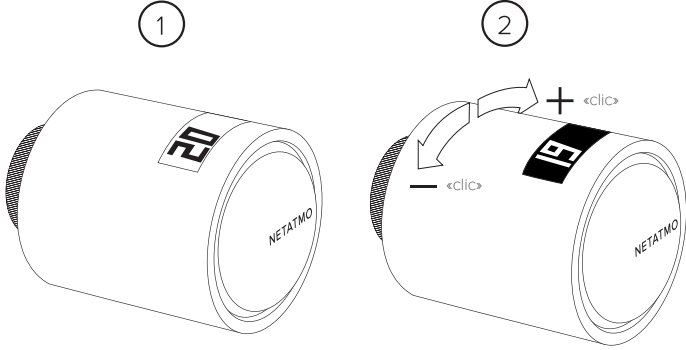

EN The display shows the room temperature (1). To increase/decrease the temperature setpoint on the Valve, twist the cylinder clockwise/ anticlockwise. The manual setpoint is temporarily displayed on a black background (2).

TR Ekran oda sıcaklığını göstermektedir. (1) Arttırmak / azaltmak için silindiri saat yönüne / saat yönünün tersine çevirin. Manual ayar noktası siyah arka planda görünmektedir.

Installation advice

Kurulum önerileri

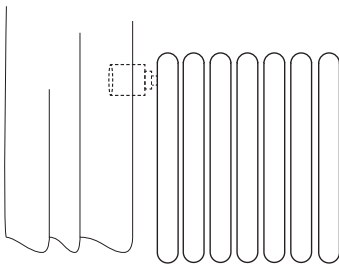
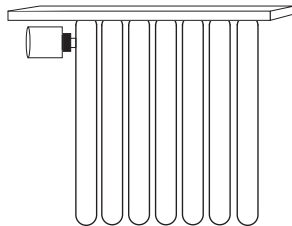

EN

Installation advice

Do not block air ventilation next to the Valve (curtain, radiator cover...)
Do not cover.

TR

Kurulum önerileri

Valfin yanındaki havalandırmayı engellemeyin (perde, radyatör kapağı...) Üstünü örtmeyin.

Technical specification

ENGLISH

SIZE

Valve: 58 mm (diameter), 80 mm (L)
Relay: 83 x 83 x 24 mm

WEIGHT

Valve: 186 g (including batteries)
Relay: 110 g (excluding the power plug)

DESIGN

Designed by Starck

SENSORS AND MEASUREMENTS

Temperature (measurement):
Range: 0°C to 50°C
Accuracy: +/- 0.5°C

Temperature (setpoint):
Range: 5°C to 30°C
Increment: 0.5°C

Motor:
Linear motion: 8 mm max
Noise level: < 35 dBA
Spring force: 80 N max

E-PAPER DISPLAY

Energy efficient, longer battery life and optimal readability.

FREE APP, LIFETIME SUPPORT

No subscription fee. App available on the App Store and on Google Play. Free access to your online personal dashboard. Accessible from multiple devices.

WIRELESS SPECIFICATIONS

802.11 b/g/n compatible
(2.400-2.496 GHz @ 100mW).
Supported security: Open/WEP/WPA/ WPA2-
personal (TKIP and AES).
Wireless connection between Valves and
Relay: long-range radio (868.9-869.1,
869.7-869.9 MHz @16mW).

POWER AND BATTERIES (PER VALVE)

Two 1.5V AA batteries.
Two year-battery life.

SETUP AND COMPATIBILITY (PER VALVE)

6 radiator adaptors suitable for use with the
following valve bodies: M30x1.5, M30x1.0,
M28x1.5, Danfoss RAVL, Danfoss RA,
Giacomini.

HOMEKIT

Controlling this HomeKit-enabled accessory automatically and away from home requires an Apple TV with tvOS 10 or later or an iPad with iOS 10 or later set up as a home hub. Communication between iPhone, iPad, or iPod touch and the HomeKit-enabled Relay is secured by HomeKit technology.

SAFETY WARNINGS

This device must be installed according to the applicable norms. Use only with supplied power plug adaptor. This device is for indoor use only. Before inserting the batteries, check that the contacts in the device and on the batteries are clean, is necessary clean them. Note the polarity (+/-) when inserting the batteries. Do not throw the batteries into a fire, short-circuit them or dismantle them. Keep children away from batteries. Seek medical attention immediately if a battery is swallowed. Do not attempt to repair the device yourself; customer service is available.

Any changes or modifications to this unit not expressly approved by the party responsible for compliance could void the user's authority to operate the equipment.

Relay insulation: class II devices.

This device is not intended for use by persons (including children) with reduced physical, sensory or mental capabilities, or lack of experience and knowledge, unless they have been given supervision or instruction concerning use of the appliance by a person responsible for their safety. Children should be supervised to ensure that they do not play with the appliance.

LEGAL NOTICE

Use of the Works with Apple HomeKit logo means that an electronic accessory has been designed to connect specifically to iPod, iPhone or iPad, respectively, and has been certified by the developer to meet Apple performance standards. Apple is not responsible for the operation of this device or its compliance with safety and regulatory standards.

Please note that the use of this accessory with iPod, iPhone, or iPad may affect wireless performance.

Teknik özellikler

TÜRKÇE

BOYUT

Vana: 58 mm (çap), 80 mm (Uzunluk)
Röle: 83 x 83 x 24 mm

AĞIRLIK

Vana: 186 g (piller dahil)
Röle: 110 g (fiş hariç)

TASARIM

Starck tarafından tasarlanmıştır

SENSOR VE ÖLÇÜMLER

Sıcaklık (ölçümler)
Aralık: 0°C to 50°C
Artış: +/- 0.5°C

Motor:

Lineer hareket: 8 mm maksimum
Ses Seviyesi: <35dBA
Yay kuvveti: 80 N maksimum

EKRAN

Enerji verimliliği, uzun pil ömrü, optimal okunabilirlik

BEDAVA UYGULAMA, ÖMÜR BOYU DESTEK

Abonelik ücreti yok. Uygulama App Store'da ve Google Play'de mevcuttur. Çevrimiçi kişisel gösterge tablonuza ücretsiz erişim. Birden fazla cihazdan erişilebilir.

KABLOSUZ BAĞLANTI ÖZELLİKLERİ

802.11 b/g/n uyumlu
(2.400-2.496 GHz @ 100mW).
Güvenlik: Open/WEP/WPA/ WPA2-personal (TKIP and AES).
Röle ve Valf arası kablosuz bağlantı: long-range radio (868.9-869.1, 869.7-869.9 MHz @16mW).

GÜÇ VE PİLLER

İki 1.5V AA piller
İki yıllık pil ömrü

KURULUM VE UYUMLULUK

Aşağıdaki valf gövdeleri ile kullanıma uygun 6 radyatör adaptörü: M30x1.5, M30x1.0, M28x1.5, Danfoss RAVL, Danfoss RA, Giacomini..

HOMEKIT

Bu HomeKit özellikli aksesuar otomatik olarak ve uzaktan kontrol etmek için tvOS 10 veya daha yeni bir Apple TV veya iOS 10 veya daha yeni bir iPad, ev hub'ı olarak kurulmalıdır. iPhone, iPad veya iPod touch ile HomeKit özellikli Röle arasındaki iletişim HomeKit teknolojisi ile güvence altına alınmıştır.

GÜVENLİK UYARILARI

Bu cihaz uygulama normlarına uygun kurulmalıdır. Sadece verilen güç adaptörü ile kullanın. bu cihaz sadece iç mekan kullanımı içindir. Pilleri yerleştirmeden önce, pillerin temiz olduğundan ve polariteye dikkat edildiğinden emin olun. Pilleri ateşe atmayın, kısa devre ettirmeyin. Çocukları pillerden uzak tutun. Piller yutulursa acil olarak medikal yardım alın. Cihazı kendi başınıza tamir etmeye çalışmayın. .

Bu ünite, uyumluluktan sorumlu tarafça açıkça onaylanmayan değişiklik ya da düzenleme yapılması, kullanıcının ekipmanı kullanma yetkisini geçersiz kılabilir.

Röle İzolasyonu: sınıf II cihaz.

Bu cihaz, güvenlikten sorumlu bir kişi tarafından cihazın kullanımına ilişkin gözetim veya talimat verilmedikçe, fiziksel, duyuusal veya zihinsel yetenekleri azalmış veya deneyim ve bilgi eksikliği olan kişiler (çocuklar dahil) tarafından kullanılmak üzere tasarlanmamıştır. Çocuklar, cihazla oynamalarını sağlamak için gözetim altında tutulmalıdır.

YASAL UYARI

Works with Apple HomeKit logosunun kullanılması, elektronik bir aksesuarın sırasıyla iPod, iPhone veya iPad'e bağlanmak için tasarlandığı ve geliştirici tarafından Apple performans standartlarını karşıladığı onaylandığı anlamına gelir. Apple, bu cihazın çalışmasından veya güvenlik ve düzenleme standartlarına uymasından sorumlu değildir. Bu aksesuarın iPod, iPhone veya iPad ile kullanılmasının kablosuz performansını etkileyebileceğini lütfen unutmayın.

EU Declaration of Conformity

Česky [Czech] - Netatmo tímto prohlašuje, že tento NRV01/TPG01 je ve shodě se základními požadavky a dalšími příslušnými ustanoveními směrnice 2014/53/UE a ROHS 2011/65/ES. Originální EU prohlášení o shodě lze nalézt na <http://www.netatmo.com/declaration/nvp>.

Dansk [Danish] - Undertegnede Netatmo erklærer herved, at følgende udstyr NRV01/TPG01 overholder de væsentlige krav og øvrige relevante krav i direktiv 2014/53/UE og ROHS 2011/65/EF. Den oprindelige EU-overensstemmelseserklæring kan findes på <http://www.netatmo.com/declaration/nvp>.

Deutsch [German] - Hiermit erkläre Netatmo, dass sich das Gerät NRV01/TPG01 in Übereinstimmung mit den grundlegenden Anforderungen und den übrigen einschlägigen Bestimmungen der Richtlinie 2014/53/UE und ROHS 2011/65/EG befindet. Die Original-EU-Konformitätserklärung finden Sie unter <http://www.netatmo.com/declaration/nvp>.

Eesti [Estonian] - Käesolevaga kinnitab Netatmo seadme NRV01/TPG01 vastavust direktiivi 2014/53/UE ja ROHS 2011/65/UE põhinõuetele ja nimetatud direktiivis tulenevatele teistele asjakohastele sätetele. Vastavusdeklaratsiooni teksti saab veebilehelt <http://www.netatmo.com/declaration/nvp>.

English - Hereby, Netatmo declares that this NRV01/TPG01 is in compliance with the essential requirements and other relevant provisions of Directive 2014/53/UE and ROHS 2011/65/EC. The original EU declaration of conformity may be found at <http://www.netatmo.com/declaration/nvp>.

Español [Spanish] - Por medio de la presente Netatmo declara que el NRV01/TPG01 cumple con los requisitos esenciales y cualesquiera otras disposiciones aplicables o exigibles de la Directiva 2014/53/UE y ROHS 2011/65/CE. El original de la declaración de conformidad UE se puede encontrar en <http://www.netatmo.com/declaration/nvp>.

Ελληνική [Greek] - Με την παρούσα Netatmo δηλώνει ότι NRV01/TPG01 συμμορφώνεται προς τις ουσιαστικές απαιτήσεις και το λοιπό σχετικό διάταξιο της οδηγίας 2014/53/UE και ROHS 2011/65/ΕΚ. Μπορείτε να βρείτε ένα αντίγραφο της πλήρους δήλωσης συμμόρφωσης στη διεύθυνση <http://www.netatmo.com/declaration/nvp>.

Français [French] - Par la présente Netatmo déclare que l'appareil NRV01/TPG01 est conforme aux exigences essentielles et aux autres dispositions pertinentes de la directive 2014/53/UE et ROHS 2011/65/CE. La déclaration de conformité UE originale est disponible sur <http://www.netatmo.com/declaration/nvp>.

Hrvatski [Croatian] - Ovime, Netatmo izjavljuje da je ovaj NRV01/TPG01 u skladu s osnovnim zahtjevima i drugim relevantnim odredbama Direktive 2014/53/UE i ROHS 2011/65/EC. Kopija pune Izjave o sukladnosti može se preuzeti na <http://www.netatmo.com/declaration/nvp>.

Italiano [Italian] - Con la presente Netatmo dichiara che questo NRV01/TPG01 è conforme ai requisiti essenziali ed alle altre disposizioni pertinenti stabilite dalla direttiva 2014/53/UE e ROHS 2011/65/CE. La dichiarazione di conformità UE originale si trova a <http://www.netatmo.com/declaration/nvp>.

Latviski [Latvian] - Ar šo Netatmo deklarē, ka NRV01/TPG01 atbilst Direktīvas 2014/53/UE un ROHS 2011/65/EK būtiskajām prasībām un citiem ar to saistītajiem noteikumiem. Pilnas atbilstības deklarācijas kopiju var iegūt vietnē <http://www.netatmo.com/declaration/nvp>.

Lietuvių [Lithuanian] - Šiuo Netatmo deklaruoja, kad šis NRV01/TPG01 atitinka esminius reikalavimus ir kitas 2014/53/UE ir ROHS 2011/65/EB Direktyvos nuostatas. Originali EU atitikties deklaracija yra <http://www.netatmo.com/declaration/nvp>.

Nederlands [Dutch] - Hierbij verklaart Netatmo dat het toestel NRV01/TPG01 in overeenstemming is met de essentiële eisen en de andere relevante bepalingen van richtlijn 2014/53/UE en ROHS 2011/65/EG. De oorspronkelijke EU-verklaring van overeenstemming is te vinden op <http://www.netatmo.com/declaration/nvp>.

Malti [Maltese] - Hawnhekk, Netatmo, jidkijara li dan NRV01/TPG01 jikkonforma mal-htidgijiet essenzjali u mal-provvedimenti oħrajn rilevanti li hemm fid-Direttiva 2014/53/UE u ROHS 2011/65/EC. Kopja tad-Dikjarazzjoni shiha ta 'konformità tista' tinkiseb fuq <http://www.netatmo.com/declaration/nvp>.

Magyar [Hungarian] - Alulírott, Netatmo nyilatkozom, hogy a NRV01/TPG01 megfelel a vonatkozó alapvető követelményeknek és az 2014/53/UE i ROHS 2011/65/EC irányelv egyéb előírásainak. Az eredeti EU megfelelőség nyilatkozat megtalálható a <http://www.netatmo.com/declaration/nvp> oldalon.

Norsk [Norwegian] - Erklærer herved Netatmo at dette NRV01/TPG01 er i samsvar med de grunnleggende krav og øvrige relevante krav i direktiv 2014/53/UE og ROHS 2011/65/EC. En kopi av den fullstendige samsvarserklæringen kan fås ved <http://www.netatmo.com/declaration/nvp>.

Polski [Polish] - Niniejszym Netatmo oświadczam, że NRV01/TPG01 jest zgodny z zasadniczymi wymogami oraz pozostałymi stosownymi postanowieniami Dyrektywy 2014/53/UE i ROHS 2011/65/EC. Kopię pełnej deklaracji zgodności można pobrać pod adresem <http://www.netatmo.com/declaration/nvp>.

Svenska [Swedish] - Härmed intygar Netatmo att denna NRV01/TPG01 står i överensstämmelse med de väsentliga egenskapskrav och övriga relevanta bestämmelser som framgår av direktiv 2014/53/UE och ROHS 2011/65/EG. En kopia av hela Konformitetsdeklarationen finns på <http://www.netatmo.com/declaration/nvp>.

Português [Portuguese] - Netatmo declara que este NRV01/TPG01 está conforme com os requisitos essenciais e outras disposições da Directiva 2014/53/UE e ROHS 2011/65/CE. Uma cópia completa da declaração de conformidade pode ser obtida em <http://www.netatmo.com/declaration/nvp>.

Română [Romanian] - Astfel, Netatmo declară că acest NRV01/TPG01 este în conformitate cu cerințele esențiale și altele prevădute de Directiva 2014/53/UE și ROHS anulii 2011/65/CE. O copie a declarației de conformitate completă poate fi obținută la <http://www.netatmo.com/declaration/nvp>.

Slovensko [Slovenian] - Netatmo izjavlja, da je ta NRV01/TPG01 v skladu z bistvenimi zahtevami in ostalimi relevantnimi določili direktive 2014/53/UE in ROHS 2011/65/ES. Kopijo celotne izjave o skladnosti najdete na spletni povezavi <http://www.netatmo.com/declaration/nvp>.

Slovensky [Slovak] - Netatmo týmto vyhlasuje, že NRV01/TPG01 spĺňa základné požiadavky a všetky príslušné ustanovenia Smernice 2014/53/UE a ROHS 2011/65/ES. Úplné znenie Vyhlásenia o zhode nájdete na webovej stránke <http://www.netatmo.com/declaration/nvp>.

Suomi [Finnish] - Netatmo vakuuttaa täten että NRV01/TPG01 tyyppinen laite on direktiivin 2014/53/UE ja ROHS 2011/65/EY oleellisten vaatimusten ja sitä koskevien direktiivin muiden ehtojen mukainen. Alkuperäinen EU-vaatimustenmukaisuusvakuutus on osoitteesta <http://www.netatmo.com/declaration/nvp>.

Türkçe [Turkish] - Netatmo, bu NRV01/TPG01'in 2014/53/UE ve ROHS 2011/65/EC Yönetmeliğinin temel şartlarına ve diğer ilgili hükümlerine uygun olduğunu beyan eder. Tam uygunluk beyanının bir kopyası <http://www.netatmo.com/declaration/nvp> adresinden edinilebilir.

български [Bulgarian] - С настоящото Netatmo декларира, че това NRV01/TPG01 е в съответствие със съществените изисквания и другите приложения разпоредби на Директива 2014/53/UE и ROHS 2011/65/EC. Копие от пълния декларацията за съответствие може да бъде получена на <http://www.netatmo.com/declaration/nvp>.

Netatmo SAS – 93, rue Nationale – 92100 Boulogne-Billancourt



Boulogne-Billancourt, 12/06/2017
CEO
Frédéric POTTER

NETATMO

EN HomeKit setup code | XX HomeKit setup code

┌ ┐

└ ┘

 <http://support.netatmo.com>



Copyright Netatmo © 2017 All rights reserved.

Reproduction and distribution prohibited without written authorization from Netatmo

Apple and the Apple logo are trademarks of Apple Inc., registered in the U.S. and other countries.

App Store is a service mark of Apple Inc., registered in the U.S. and other countries.

Google Play and the Google Play logo are trademarks of Google Inc.

QSG-NVP-V6